

# **MP5SF**

- Single-Fire -

BRIEF DESCRIPTION  
OF THE  
**MP 5 SF**  
SUBMACHINE GUN

- Single-Fire -

## GENERAL

The MP5SF Submachine Gun, for 9 mm x 19 (Luger) ammunition, is an semi-automatic small arm produced in accordance with the most advanced manufacturing methods. It permits single shots or bursts to be fired from all positions.

The submachine gun is recoil-operated, with stationary barrel and delayed roller locked bolt system.

Its high accuracy in the single-fire mode results from the fact that the submachine gun fires from closed bolt position, in conjunction with the recoil operated delayed roller locked bolt system.

The MP5SF offers absolute safety because it fires from the closed bolt position.

The ammunition is fed from a 15- or 30-round magazine.

### Models:

1. MP5SF with fixed butt stock (Fig. 1)
2. MP5SF with retractable butt stock (Fig. 2)



Fig. 1 MP5SF with fixed butt stock



Fig. 2 MP5SF with retractable butt stock

### ASSEMBLIES

1. Receiver with barrel, cocking mechanism and sights
2. Bolt assembly
3. Pistol grip with trigger mechanism
4. Fixed butt stock; retractable butt stock
5. Handguard
6. Magazine

Accessories (page 18)



Fig. 3 Assemblies

### DESCRIPTION OF ASSEMBLIES

#### Assembly 1 Receiver with barrel, cocking mechanism and sights

The receiver connects the barrel, cocking mechanism and sights. In addition, all assemblies are either contained in the receiver or attached to it (Fig. 4).

The barrel is press-fitted into the barrel extension and fixed in place by means of pins. The cocking mechanism is located above the barrel and is employed for manually cocking and loading the weapon and for securing the bolt in its rearmost position.

The sights consist of the front sight and rotary rear sight. The rear sight has 4 aperture positions; the apertures, which differ in diameter, all correspond to a uniform sight setting (sighting shot) for firing at ranges of 25 and 100 m. Being able to select a particular aperture diameter permits perfect individual aiming by means of the rear sight aperture, front sight and the outer circumference of the front sight cover. The rotary rear sight can be adjusted for elevation and windage.



Fig. 4 Receiver with barrel, cocking mechanism and sights

### Assembly 2 Bolt assembly

The bolt assembly (Fig. 5) consists of the following elements:

- Bolt head carrier with recoil spring tube (Fig. 6)
- Recoil spring guide rod and recoil spring (Fig. 7)
- Bolt head with locking rollers, extractor and extractor spring (Fig. 8)
- Locking piece (Fig. 9)
- Firing pin spring (Fig. 10)
- Firing pin (Fig. 11)

The bolt assembly is housed and guided in the receiver; in conjunction with the recoil spring, it feeds and fires the cartridge, extracts and ejects the empty cartridge case after firing, and cocks the hammer.



Fig. 5 Bolt assembly

Recoil spring tube



Fig. 6 Bolt head carrier with recoil spring tube



Fig. 7 Recoil spring guide rod with recoil spring

Extractor with extractor spring



Locking roller

Fig. 8 Bolt head



Fig. 9 Locking piece



Fig. 10 Firing pin spring



Fig. 11 Firing pin

**Assembly 3** Pistol grip with trigger mechanism

The pistol grip (Fig. 12) is hinged to the receiver and can be swung down and removed from it; it contains the trigger housing (Fig. 13), with components of the trigger and safety mechanism. The safety axle connects the trigger housing to the pistol grip.



Fig. 12 Pistol grip with trigger mechanism



Fig. 13 Trigger housing with trigger mechanism and safety components

#### Assembly 4 Butt stock

##### Fixed butt stock

The fixed butt stock (Fig. 14) closes the rear of the receiver. It is connected to the receiver by a locking pin.

The sling holder is attached to the butt stock by means of tubular rivets, which are also employed for safekeeping of the locking pins when the weapon is field stripped.

##### Retractable butt stock

The fixed butt stock can be replaced by a retractable butt stock (Fig. 15) when required.

The two guide rails on either side of the butt stock are guided in grooves on the receiver. They are secured by a locking catch in both the retracted and extended positions.

A sling holder is attached to the back plate.



Fig. 14 Fixed butt stock

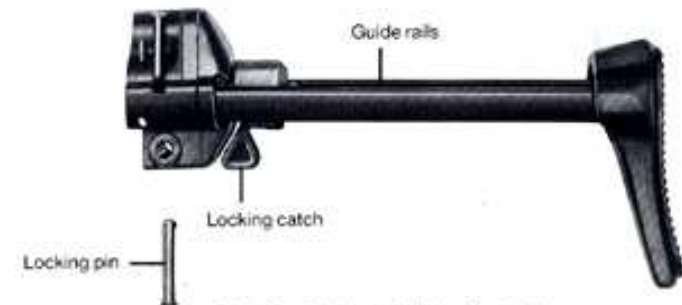

Fig. 15 Retractable butt stock



**Assembly 5 Handguard**

The detachable handguard (Fig. 16) encircles the barrel from below. It is attached to the weapon by a locking pin.



Fig. 16 Handguard

### Assembly 6 Magazine

The magazine holds 15 or 30 rounds and is employed for feeding the cartridges to the submachine gun.

The magazine consists of:

- Magazine housing (Fig. 17)
- Floor plate (Fig. 18)
- Follower with follower spring and locking plate (Fig. 19)



Fig. 17 Magazine housing



Fig. 18 Floor plate



Fig. 19 Follower, with follower spring and locking plate

## ACCESSORIES

### Multi-purpose carrying sling

The multi-purpose carrying sling (Fig. 20) is employed for carrying the submachine gun, while permitting the shooter to fire immediately from all positions (see pages 44–47).

### Blank attachment

The blank attachment (Fig. 21) permits blank ammunition to be fired. For better identification, it is prominently marked with a colouring ring. Powder residues can be removed by soaking the blank attachment in kerosene.

### Flash-hider

The flash-hider (Fig. 22) is attached onto the barrel.



Fig. 20 Multi-purpose carrying-sling



Fig. 21 Blank attachment



Fig. 22 Flash-hider

## HANDLING AND OPERATION

### Filling the magazine

Hold the magazine in one hand (Fig. 23); with your other hand, place the cartridge in the magazine opening, pressing the uppermost cartridge under the lip with your thumb.

### Emptying the magazine

Hold the magazine in one hand, with the bullet end of the cartridges pointing toward your other hand (Fig. 24). Using your thumb, push the cartridges to the right, into your open hand.

**Note:** A magazine filler and emptier is available for both operations.



Fig.23 Filling the magazine



Fig. 24 Emptying the magazine

A fire/safety catch lever is located on either side of the pistol grip. It can be set at two positions:

 = Safe (Fig. 25)

 = Single-fire (Fig. 26)

Put at safe! The fire/safety catch lever must point to symbol  .

The trigger cannot be squeezed but cocking operations are possible.

Firing: The fire/safety catch lever must point to symbol  .



Fig. 25 Safe



Fig. 26 Single-fire

### Inserting and removing the magazine

Engage the safety!

Insert magazine into the magazine well (Fig. 27) until you hear the magazine catch engage.

To remove the magazine, push the magazine release lever (Fig. 28).



Fig. 27 Inserting the magazine



Fig. 28 Removing the magazine

### Loading the submachine gun

Engage the safety!

Retract the cocking lever with your left hand and engage it in the recess in the receiver (Fig. 29).

Insert a loaded magazine into the magazine well until you hear the magazine catch engage (Fig. 27).

**Disengage the cocking lever and let it snap forward.**

The weapon is now loaded and on "Safe".



Fig. 29 Retracting the cocking lever

### OPERATING PRINCIPLE

The weapon is loaded and cocked, with the safety off.

Pulling the trigger releases the hammer, which strikes the firing pin. The cartridge is ignited. The powder gases thus generated drive the bullet out of the barrel. At the same time, these gases also exert pressure on the cartridge case.

This causes forces to act on the bolt head face; a portion of these forces is transmitted to the receiver and a portion to the bolt head carrier, via the locking piece; the balanced angular ratio of the locking piece and barrel extension results in a delayed recoil movement of the bolt head.

This guarantees that the bolt keeps the barrel locked until the bullet has left the muzzle.

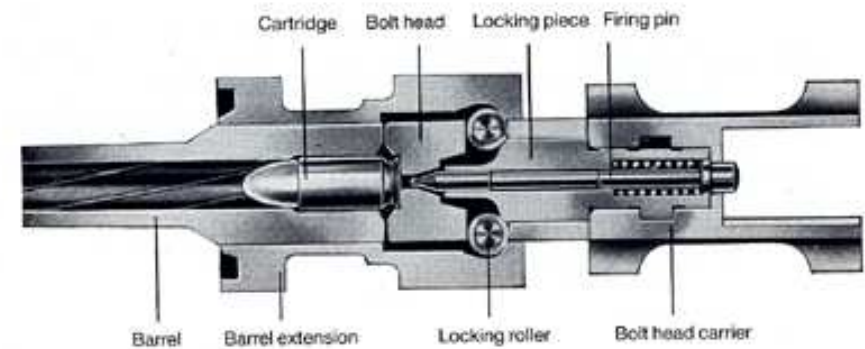

Fig. 30 Bolt in locked position



After the locking rollers have been fully cammed into the bolt head, the bolt can continue its recoil movement. In the course of this movement, the empty cartridge case is ejected and the hammer recocks.

At the same time, the recoil spring is compressed, which returns the bolt to its forward position. During the course of this process, a new round is chambered from the magazine. The extractor engages the extracting groove in the cartridge case. As a result of the bevelled surfaces of the locking piece, the locking rollers are cammed against the supporting surfaces in the barrel extension (Fig. 31). The weapon is now ready to fire again.

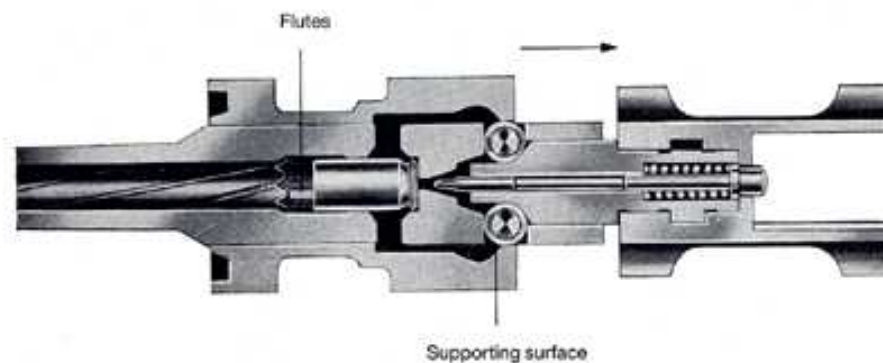

Fig. 31 Bolt in unlocked position

## STRIPPING THE SUBMACHINE GUN

Engage the safety!

Remove magazine.

Unload chamber; retract cocking lever and make sure that the chamber is clear. Then let cocking lever snap forward.

Unhook multi-purpose sling from front sight holder.

Remove butt stock locking pin and place it in the tubular rivet in the fixed butt stock (Fig. 32).

Slide off butt stock; swing down or remove pistol grip. Using the cocking lever, retract bolt head assembly with recoil spring and remove them from the receiver (Fig. 33).

Detach handguard.



Fig. 32 Removing the butt stock



Fig. 33 Removing the bolt assembly

### Stripping the bolt assembly

Remove recoil spring from recoil spring tube by edging it off in the rear-most position.

Rotate bolt head 90° toward your body and detach it from the locking piece. Remove locking piece, firing pin and firing pin spring from the bolt head carrier (Figs. 34 and 35).

**To reassemble the bolt assembly,** insert firing pin, firing pin spring and locking piece into the bolt head. Insert all parts in the bolt head carrier in such a manner that the lug on the locking piece is guided through the recess in the bore of the bolt head carrier.

Rotate bolt head until you hear it engage.

Press recoil spring into the recoil spring tube.

**Stripping the pistol grip** with trigger mechanism.

Uncock hammer (spring).

Rotate selective fire lever until it is in a vertical position, then pull out.

Remove trigger assembly housing.

**Note:** Further stripping of the trigger assembly housing may only be performed by ordnance personnel. If the trigger assembly housing is severely fouled, it can be washed out in a cleaning solvent.



Fig. 34 Removing the bolt assembly components



Fig. 35 Stripping the bolt assembly

### ASSEMBLING THE SUBMACHINE GUN

Attach handguard.

Insert the assembled bolt assembly, including recoil spring, into the receiver.

Attach pistol grip and swing it into position.  
(Set fire selector lever on pistol grip to "S".)

Push the fixed or retractable butt stock onto the receiver and press locking pin into place (Fig. 36).

Attach the multi-purpose carrying sling.

Check the weapon for proper assembly by performing several cocking motions.

### JAMMING AND MALFUNCTIONS

**Always!** Cock and continue firing.

Should the weapon fail to fire, engage the safety, remove the magazine, unload the weapon and determine the source of trouble.



Fig. 36 Assembling the submachine gun

### ADJUSTING THE ROTARY REAR SIGHT

Any corrections which may be required when sighting-in the weapon may only be performed by adjusting the rear sight for elevation or windage.

#### **Elevation adjustment:**

Insert elevation adjustment tool into the rear sight cylinder (Fig. 37) in such a manner that the wedges of the tool engage the two splines in the cylinder, which contain the catch bolts. Press Phillips-head screwdriver downward into the adjustment tool and hold firmly.

Rotate rear sight cylinder manually in the desired direction (rotating clockwise lowers the strike 1,4 cm (0.55 in.) per click at a range of 25 m, rotating counterclockwise raises it correspondingly).

After performing the correction, withdraw Phillips-head screwdriver and remove elevation adjustment tool. The catch bolts will then re-engage in the splines.

After performing the **elevation adjustment**, set the desired aperture again.



Fig. 37 Elevation adjustment

**Windage adjustment:**

Correction of left-hand deviation: Loosen clamping screw (Fig. 38). Turn adjusting screw (Fig. 39) counterclockwise, in accordance with the required correction. Then retighten clamping screw.

Correction of right-hand deviation: Loosen clamping screw (Fig. 38). Turn adjusting screw (Fig. 39) clockwise until the required correction is obtained. Then retighten clamping screw.

Note: Each revolution of the adjusting screw moves the mean strike 5.5 cm (2.16 in.) to the left or right at a range of 25 m.



Fig. 38  
Loosening the clamping screw



Fig. 39  
Rotating the adjusting screw

### USING THE MULTI-PURPOSE CARRYING SLING

The multi-purpose carrying-sling is attached to the front of the weapon by inserting its carbine hook into the eye on the front sight holder; at the rear, its loop and hook are attached to the butt stock.

When employed as a normal carrying sling, the double loop hangs from the carbine hook. To convert the sling to the "ready" carrying mode (Fig. 42), pull the double loop over the carbine hook (Fig. 40) and attach to the receiver, depending upon how the sling is worn.

Set the multi-purpose carrying sling to the proper length for the individual shooter by readjusting the sliding buckle. The correct sling length can be checked by assuming the desired firing position.

When slinging the weapon (Fig. 41), one half of the sling (1) should extend over the shooter's back, with the other half (2) resting across his chest.



Fig. 40 Pulling the double loop over the carbine hook

- Shown here on the HK 33 Rifle -



Fig. 41 How to wear the multi-purpose carrying sling

## Carrying and slinging modes



Fig. 42



Fig. 43



Fig. 44

## Firing positions

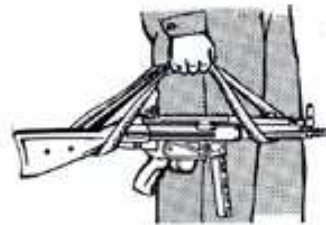

Fig. 45



Fig. 46

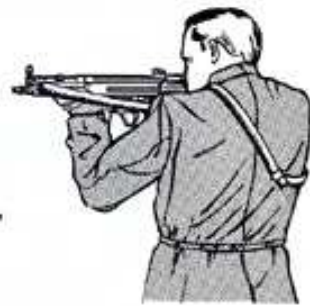
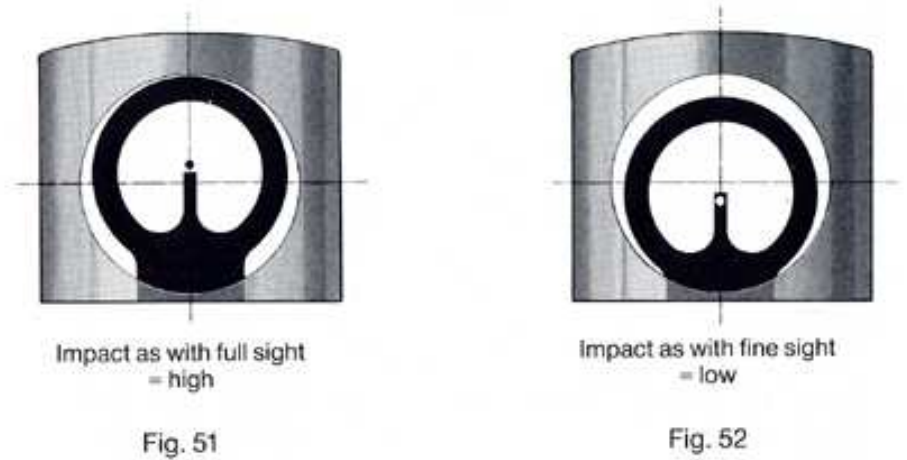
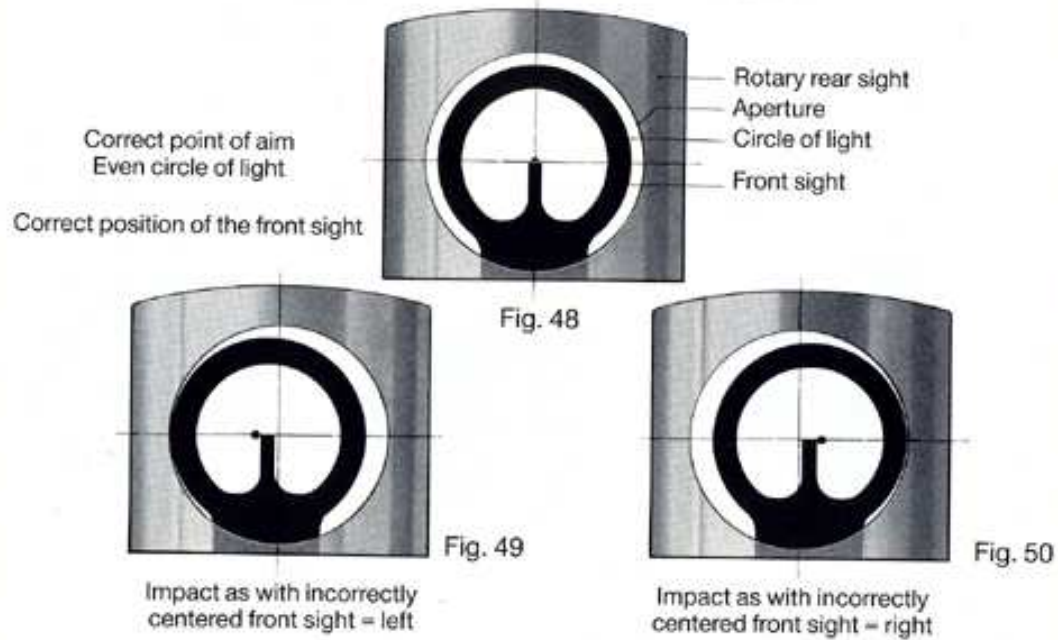

Fig. 47



## Sight pictures for MP5 Submachine Gun



### SPECIFICATIONS, MP5SF

Muzzle velocity - $V_0$ - . . . . .	approx. 1312 f.p.s. (400 m/sec)
Muzzle energy - $E_0$ - . . . . .	470 ft.lbs (650 J)
6 grooves with constant right-hand twist	
Sighting shot . . . . .	25 and 100 m
Maximum height of trajectory above the line of sight at a range of 50 to 60 m . . . . .	4.33 in. (11 cm)
<b>Weights</b>	
Weight of weapon with fixed butt stock, without magazine . . . . .	5.59 lbs (2.54 kg)
Weight of weapon with retractable butt stock, without magazine . . . . .	6.34 lbs (2.88 kg)
Steel magazine for 30 rounds, empty . . . . .	6.0 oz. (0.17 kg)
Cartridge . . . . .	185 gr. (12 g)
<b>Lengths</b>	
Length of weapon with fixed butt stock . . . . .	26.77 in. (680 mm)
Length of weapon with retractable butt stock . . . . .	25.98 in. (660 mm)
Length of weapon with butt stock retracted . . . . .	19.29 in. (490 mm)
Line of sight . . . . .	13.39 in. (340 mm)
Barrel . . . . .	8.85 in. (225 mm)
Cartridge case . . . . .	0.74 in. ( 19 mm)

### TABLE OF CONTENTS

	Page
General . . . . .	2
Assemblies . . . . .	4
Description of assemblies . . . . .	6
Handling and operation . . . . .	20
Operating principle . . . . .	28
Stripping the submachine gun . . . . .	32
Assembling the submachine gun . . . . .	36
Jamming and malfunctions . . . . .	36
Adjusting the rotary rear sight . . . . .	38
Using the multi-purpose carrying sling . . . . .	42
Sight pictures for submachine gun MP5SF . . . . .	46
Specifications MP5SF . . . . .	48